

LVP605 SERIES LED HD Video Processor

USER'S MANUAL



TABLE OF CONTENTS

I. Safety precautions	3
II. Packing list	4
III. Connections of hardware	
1. Rear view	5
2. Port description	5
3. Connection diagram	6
IV. Frontal panel operations	
1. Diagram of frontal panel	7
2. Button instructions (operation mode)	8
V. Setup	
(I) User parameter setup	12
1. Enter setup of LVP605	12
2. Select language	12
3. Output image setup	13
4. Text Overlay Setup	14
5. Brightness / color / Sharpness	15
6. Audio configurations	18
7. Hot Spare setup	18
8. Factory district setup	19
(II) PIP/POP setup	20
(III) Mosaic setup	22
VI. Specifications	27
VII. ViewRGB LVP605 Control Software User's Manual.....	30
VIII. Notes to model.....	42
IX. Copyright info.....	42

I. Safety Precautions

Danger!

There is high voltage in the processor, to prevent any unexpected hazard, unless you are maintenance, please do not open the cover of the device.

Warning!

1. This device shall not encounter water sprinkle or splash, please do not place anything containing water on this device.
2. To prevent fire, keep this device far from any fire source.
3. If this device gives out any strange noise, smoke or smell, please immediately unplug the power cord from receptacle, and contact local dealer.
4. **Please do not plug or unplug DVI signal cable if the device is powered on.**

Caution!

1. Please thoroughly read this manual before using this device, and keep it well for future reference.
2. In the event of lighting or when you are not going to use the device for a long time, please pull the power plug out of receptacle.
3. Nobody other than professional technicians can operate the device, unless they have been appropriately trained or under guidance of technicians.
4. To prevent equipment damage or electric shock, please don't fill in anything in the vent of the device.
5. Do not place the device near any water source or anywhere damp.
6. Do not place the device near any radiator or anywhere under high temperature.
7. To prevent rupture or damage of power cords, please handle and keep them properly.
8. Please immediately unplug power cord and have the device repaired, when
 - 1) Liquid splashes to the device.
 - 2) The device is dropped down or cabinet is damaged.
 - 3) Obvious malpractice is found or performance degrades.

II. Packing list

Please unpack the product with care, then check whether all the following things are included in the package. If anything is found missing, please contact the dealer.

Standard accessories

The accessories supplied with this LED Video Processor may differ from the figures contained in the User's Manual, but they are applicable for the regions where you live.

User's Manual



Power cord (1.5m)1pcs



Net cable(0.2m)



DVI cable (1.5m), 1pcs



DVI cable (0.5m), 1pcs



User manual CD



Rs232-RJ45 cable (1.5m) BNC-RCA adapter: 3 pcs



PCB Connector (Audio)



DVI-I to VGA adapter(only for 605D)



III. Connections of hardware

1. Rear view

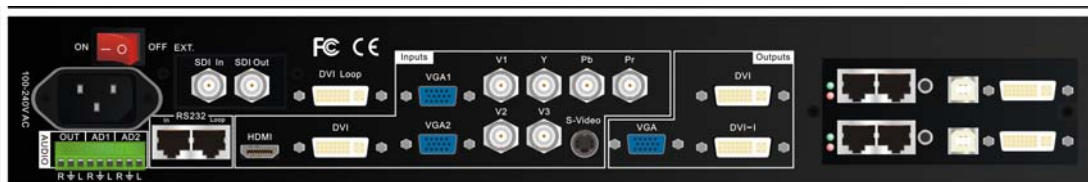

Figure 1

2. Port description

1) Video Input

LVP605 supports 10-channel signal input, including:

Port name	Description
V1~V3	3-channel PAL/NTSC composite video input
S-Video	1-channel PAL/NTSC S-video input
YPbPr	1-channel component HD signal input
VGA1~VGA2	2-channel computer analog signal input
DVI	1-channel computer DVI digital signal input
HDMI	1-channel HDMI digital HD signal input
EXT.	1-channel extended signal input

EXT. input standard signal is 1xVIDEO, which can optically be 1xSDI/HD-SDI or 1xVGA/DVI/HDMI.

2) Audio Input

LVP605 supports 5-channel stereo audio switch. Of which, 3 channels are DVI (only available when the input signals are HDMI signals), HDMI and SDI audios, the other 2 channels are AD1, AD2 external input audio. AD1 and AD2 can be mapped to the any one of all video inputs, and will be switched synchronous to the selection of video input signals.

3) Video Output

Port	Description
VGA OUT	1-channel analog RGBHV signal output, it can be connected to a local display

	device and used as monitor (it is strongly recommended to use this port when operating and setting LVP605).
DVI OUT1 / DVI OUT2	2 same DVI digital graphic signal output, it can be connected with external LED transmission card or LED transmission box
SDI / HDSDI (OUT)	1-channel digital video signal loop output (Only including this input with SDI/HDSDI extended model)
DVI Loop OUT	1-channel computer DVI digital signal loop output

4) Audio Output (AUDIO OUT)

Corresponds to the selected video input signal, output this channel audio input signals.

5) Signals of other ports

RS232 command port is used to connect PC RS232. Then the processor can be controlled by PC software. LOOP connector can connect to another processors by net cable and one signal PC can control all processors.

3. Connection diagram

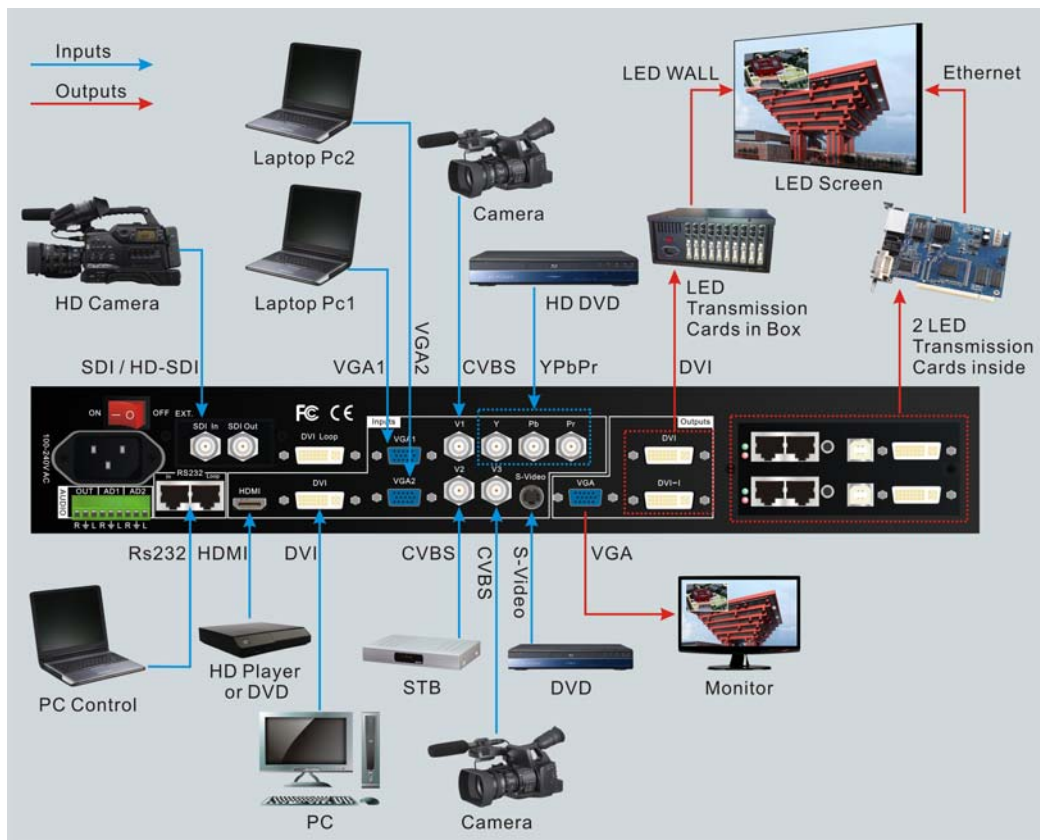

IV. Frontal panel operations

1. Diagram of frontal panel

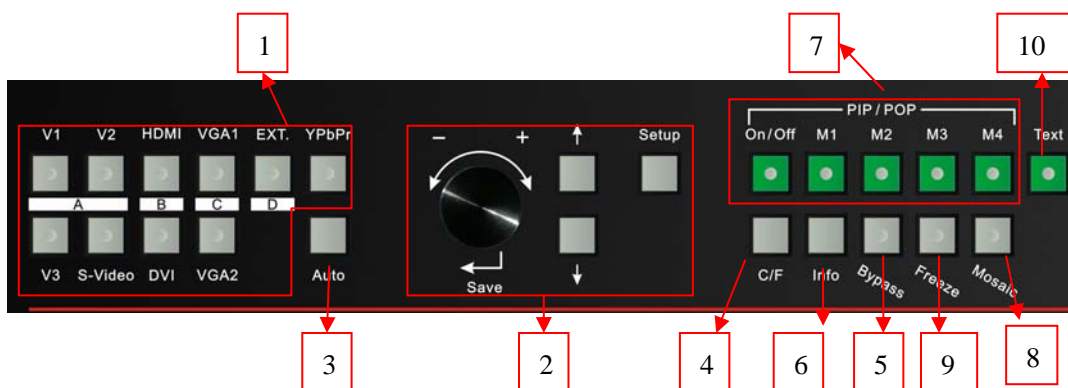

- 1) **Input selecting buttons (V1, V2, V3, S-Video, DVI, VGA1, VGA2, YPbPr, EXT.):**
They are used to select input signals
- 2) **Setup buttons (Setup, Save, ↑, ↓, ←, →)**
They are used to set the image output parameters of the processor.
- 3) **VGA auto adjustment (Auto)**

To automatically adjust VGA input signals

- 4) **Cut / Fade switching mode (C/F):**
It is used to select signal switching effects, including seamlessly switching (CUT), 0.5s, 1.0s and 1.5s Fade in / Fade out and blend.
- 5) **PC signal bypass output (Bypass):**
It is used to switch full screen/partial screen display of PC signals, and the indicator will indicate the status of current input signal.
- 6) **Info:**
It is used to display current settings and information of processor
- 7) **PIP/POP buttons (ON/OFF, M1, M2, M3, M4):**
ON/OFF: to turn on/off **PIP/POP** functions, when the indicator is on, you can select any signal coming from different groups or current signal as PIP/POP by using input selecting buttons.
M1, M2, M3, M4: used to set or switch PIP/POP modes.
- 8) **Mosaic**
It is used to turn ON/OFF multi-machine cascade mosaic function. The indicator indicates current splicing status.
- 9) **Freeze**
It is used to turn ON/OFF screen freezing function.
- 10) **Text**
It is used to add Text, company logo or animation.

2. Button instructions (operation mode):

There are 25 buttons on the frontal panel of LVP605, all these buttons will be operable after start. they have the following functions as described below:

1) Select input video source

Port name	Description
V1、 V2、 V3	3-channel PAL/NTSC composite video input
S-Video	1-channel PAL/NTSC S-video input
YPbPr	1-channel component HD signal input
VGA1、 VGA2	2-channel computer analog signal input
DVI	1-channel computer DVI digital signal input
HDMI	1-channel HDMI digital HD signal input
EXT.	1-channel extended signal input (such as SDI/HDSDI)

Switch audio input while operating above buttons; select the audio signal input from corresponding video input to output it through **Audio OUT**.

After selecting input signals, the input signal source you currently selected such as "input=HDMI" will appear in the first line

of LCD, while the status of current input signals will appear in the second line of LCD. If there are no valid signals entered, the message “no signal” will appear in LCD, and the corresponding indicator will blink and dark screen appear; if the signal is valid, the format of input signals such as “ 1080p_60Hz ” will appear in LCD.

Input= HDMI 1080p_60Hz Cut

Notes: if extended input was VGA/DVI/HDMI, we need choose input signal by hand switching to current signals. Switching to “VGA”, the current input signal is VGA. Switching to “DVI”, the current input signal is DVI or HDMI.

2) VGA input auto adjustment (Auto)

When the current VGA input source of **LVP605** is a valid signal, press this button, **LVP605** will automatically adjust the sampling parameters of the VGA signals, so as to make VGA picture clean and complete.

In general, this operation is made only when new VGA signal source is to be connected in. Sometimes user need repetitively do such adjustment till VGA picture looks clean, complete and stable.

3) Information display (Info)

Press this button to view current settings and information of **LVP605**, it consists of 25 items. If you press “**Info**” again before **LVP605** exit information display, **LVP605** will continue to display the next item of information.

4) Select Cut / Fade / Blend mode(C/F)

LVP605 can realize seamless switching effect (Cut) , fading in/out switching effect (Fade) or blend effect between any two signals from different groups as listed below.. But if the signals come from the same group, dark screen will appear.

A	B	C	D
V1, V2, V3, S-Video	DVI, HDMI	VGA1 VGA2	EXT

Cut (seamlessly switching): while in this mode, “Cut” will

appear in the third line of LCD, the system can seamlessly switch between different signals. It is also the default mode of LVP605 after startup.

Fade (fading in fading out): while in this mode, "Fade=1.0s" will appear in the third line of LCD, the system can realize fading in fading out switching effect between the signals coming from different groups. Users can set the switching time of fading in and fading out as 0.5 seconds, 1.0 second or 1.5 seconds.

Blend: The current input signal will be the background. The other signal from different group will be choosed as blend signal. Then the background signal and blend signal will be overlap showed. Then press the button of background or blend signal, the output will be the choosing signal. The whole procedure will be fade in fade out switching effect.

Notes: Neither Cut mode nor Fade modes applies to **YPbPr** signals, that is to say, if you attempt to switch between **YPbPr** signals and any other signal, dark screen will appear. YPbPr signal cannot be background signal and blend signal.

5) PIP / POP (PIP/POP: On/Off, M1, M2, M3, M4)

PIP/POP mode of LVP605 allows user to insert a PIP window in current picture, and the size and location of the PIP window can be set freely. The signals to be displayed in PIP window can be either current signal itself or any signals which are not in the same group as that of current picture. Here we call current picture "background", and call the picture to be overlaid "PIP". The following paragraphs will illustrate the operating procedures of this function:

Enter PIP display mode: Press On/Off button, its indicator will illuminate, LVP605 will enter PIP display mode, then use Preselect button to select PIP input signals, in the meantime, signals of background and PIP and their locations will appear in LCD (see Figure below):

Background: V1 PAL PIP: VGA 1280X1024 60Hz

Change PIP: While in PIP mode, use **Preselect** button to select proper input signals, the preselected signals will be set as PIP.

Change the background: you must first turn off PIP mode.

Press buttons to select appropriate input signal as background, then enter PIP mode again, and select a new PIP picture.

Switch PIP/POP display mode: LVP605 allows for presetting 4 PIP/POP display modes, each mode allows for setting its own background and PIP sizes and locations. While PIP/POP mode is switched on, user can press the mode switching buttons (M1, M2, M3, M4) to select appropriate display modes quickly.

6) Part/Full (Bypass)

Press this button to switch between Part / Full display mode.

This function is only available when the current input signal is PC (VGA 1/ VGA 2/ DVI /HDMI) signal, while other signals can only be displayed in the Full display mode.

Mode	Description
Full	Full screen display. Entire picture is compressed to display in LED screen, the moment the indicator above the button is OFF.
Part	Part screen display. The picture will not be compressed, but partly exported to entire LED screen, the moment the indicator above the button is ON.

Caution: when the width and height of current input signals are less than the width or height of LED display (say the Out_Hori_width or Out_Vert_height), Part mode will not work.

7) Freeze

Press this button, the indicator of this button will illuminate normally, and the current picture will be frozen; press this button again or perform other signal switching operations, the indicator of this button will turn out, the picture will get in motion again.

8) Mosaic

Press this button only when current signals are DVI, the indicator of this button will illuminate, LVP605 will enter Mosaic mode. Press this button again, the indicator of this button will turn out, and LVP605 will exit Mosaic mode.

Notes: LVP605 will be unable to enter Mosaic mode in the following events:

1. The input signals are other signals than DVI;

2. BYPASS function has been switched on;
3. The definition of DVI input signals is different from the preset output definition of the processor.

9) Text

LVP605 can add Text, company logo or animation onto current picture, while current picture is normally displayed, press Text button to go to caption adding mode, then select the signal source of caption. The captions can be made by office software such as Powerpoint.

V. Setup

The following settings must be made by relevant qualified technicians. For ordinary users, unless they have received adequate technical training, they shouldn't attempt to make the following settings!

There are 3 categories available for you to set in **LVP605**. Technicians can set these items as necessary, for details see the table below:

Category	Items
User parameter setup	Output image setup, text overlay setup Brightness/Color /Definition setup Hot spare setup, Audio configuration factory district setup
Mosaic setup	Input parameter setup Output parameter setup Sync. Mosaic setup
PIP/POP setup	Background and PIP output image setup

(I) User parameter setup

Category		Items	
1	Language	1	Language 语言
2	Output image setup	2	Out Format
		3	Out_Hori_Width
		4	Out_Hori_Start
		5	Out_Vert_Height
		6	Out_Vert_Start
3	text overlay setup	7	Text Mode
		8	Threshold Red
		9	Threshold Green
		10	Threshold Blue
4	Brightness/Color /Definition setup	11	Brightness
		12	Saturation
		13	Sharpness
5	Audio configuration	14	Audio1 Config
		15	Audio2 Config
6	Hot spare	16	Hot spare < V1→V3>
		17	Hot spare < V2→S-Video >
		18	Hot spare < HDMI→DVI>
		19	Hot spare <VGA1→VGA2>
		20	Device ID
'7	Factory district Setup	21	ADC Calibration
		22	Bias
		23	De interlace
		24	EXT. model
		25	Device init

1. Enter Setup of LVP605

Enter setup: While in operation mode (make sure that PIP mode and Mosaic mode have been switched off), press “**Setup**” button, then press the knob(“**Save**” key) , LVP605 will enter No.1 setup item.

Exit setup: press “Setup” button while in setup mode, LVP605 will directly exit setup.

After LVP605 enters setup mode, the knobs and 3 buttons in setup area will respectively have the functions as described in table below:

Name		Functions
Knob	Speed of knob	The step value in proportion to the speed of knob
	Turn it clockwise	Decrease value or select previous value
	Turn it anticlockwise	Increase value or select next value
	Press it	Save the adjustment or selected values
↑		Move to previous item
↓		Move to next item
Setup		Enter or exit setup mode

After **LVP605** enters setup mode, the relevant setting information will be displayed in LCD as per the layout shown in the figure below:

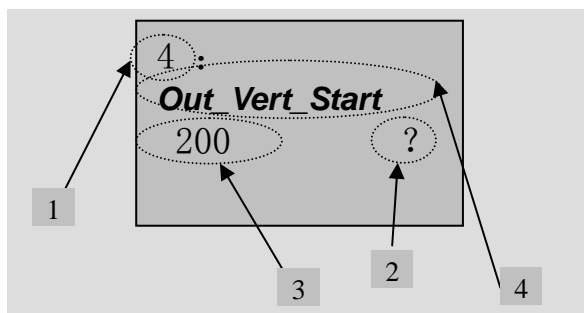

Figure 3

As shown in above figure, LCD consists of five sectors:

Sector	Description
1	The No. of current setting item
2	? : ask you whether to save the adjustment; ! : The adjustment already be saved and takes effect.
3	Newly adjusted value
4	Name of current setting item

2. Select language

Item 1: “**Language** 语言”

After entering setting mode, **LVP605** will enter the first setting item “**Language** 语言”. **LVP605** supports Chinese and English display, turn the knob to select either of them, then press the knob to save it and make it valid.

3. Output image setup

LVP605 outputs images from VGA and two DVI output ports. There are 10 output formats as listed in the table below. User can enter the No.2 setting item "**Out Format**" to select one of them.

	Format
1	1024×768_60
2	1024×768_75
3	1280×1024_60
4	1280×1024_75
5	1600×1200_60
6	1920×1080_50
7	1920×1080_60
8	1366×768_60
9	1440×900_60
10	2048×1152_60

Item 2: "**Out Format**"

In this item, turn the knob to select either of them, then press the knob to save it and make it valid.

For example, if you select "**1280×1024_60**", it means that the output definition of LVP605 has been set as 1280×1024, and vertical refresh rate is 60Hz.

Please select the output definition equal to or greater than the actual definition of LED screen.

Items 3~6: "**Output image setup**"

The actual definition of LED can be any value, so we should set LVP605 to make it output an image with the same definitions as that of the LED, so that the LED could display a full image. See figure below:

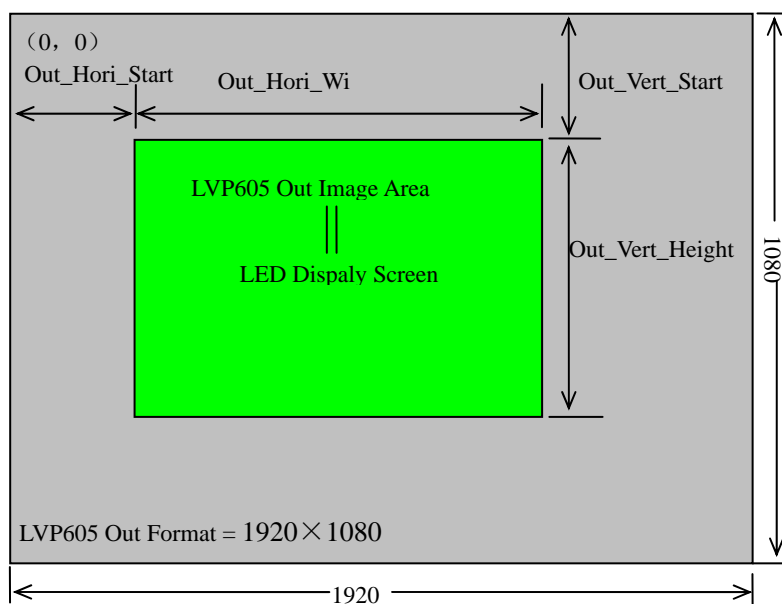

As above figure shows: the size and location of the images in **LVP605** output window for the LED display are defined by the following 4 groups of parameters:

Item No.	Parameters
3	<i>Out_Hori_Width</i>
4	<i>Out_Hori_Start</i>
5	<i>Out_Vert_Height</i>
6	<i>Out_Vert_Start</i>

Notes: user can change current parameter settings by rotating the knob. The speed at which you rotate the knob decides the step value of the adjustment. The location and size of the output image will be previewed in the white box while you are making the adjustment, then you can press the knob to save and validate the settings you made.

4 . Text Overlay Setup

Item No.	Setup Item Name
7	<i>Text Mode</i>
8	<i>Threshold Red</i>
9	<i>Threshold Green</i>
10	<i>Threshold Blue</i>

Item 7: ***“Text Mode”***

LVP605 allows user to set caption knock-out “< threshold” or “>threshold”. If it is less than threshold value, it means that the image of caption signal less than current color threshold value will be added to background, while the part greater than threshold will be automatically filtered. If it is greater than threshold value, it means that the image of caption signal greater than current color threshold value will be added to background.

Item 7~10: ” *Threshold Red/Green/Blue*”

The three options are used to set R, G, B values respectively as a certain value within 0~248.

The following figure shows an example of caption adding function. The caption document in this sample is made using Powerpoint. Its parameters are set as below:

No. of setup item	Setup Item Name	parameters
7	Text Mode	<Threshold
8	Threshold Red	248
9	Threshold Green	248
10	Threshold Blue	248

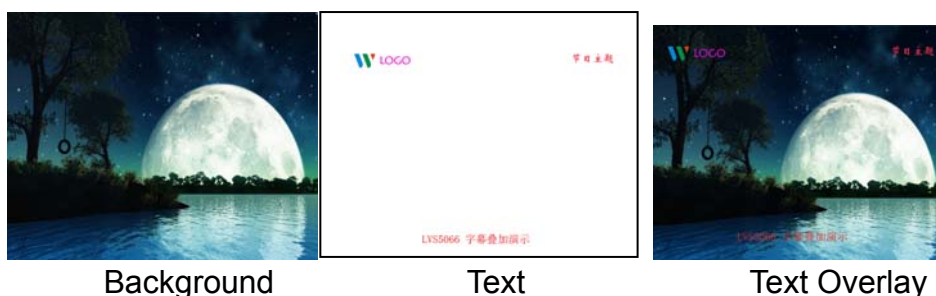

5. Brightness / Situration/ Sharpness

LVP605 supports customized brightness, color Saturation and definition settings. For details see table below:

Item No.	Description	Definition
11	Brightness	Range: 0~100, default value: 50
12	Saturation	Range: 0~100, default value: 50
13	Sharpness	Option is “Sharp” or “Normal”, default value: Normal

Caution: (1). In order to ensure output images in complete gray, the

output parameters are usually set as default values !

(2). The color parameters only apply to V1、V2、V3、S-Video、YPbPr、SDI and HDMI signals.

6. Audio configurations

LVP605 supports 3-channel stereo audio switch. Of which, 3 channels are DVI (only available when the input signals are HDMI signals), HDMI and SDI audios,, the other 2 channels are **AD1**, **AD2** external input audio. **AD1** and **AD2** can be mapped to the any one of all video inputs, and will be switched synchronous to the selection of video input signals.

If **DVI(or SDI, HDMI)** is configured as external input audio, when audio signal is switched to **DVI(or SDI, HDMI)**, external audio will be chosen as input signals, otherwise the audio signals contained in **DVI(or SDI, HDMI)** signals will be chosen as input signals.

Item No.	Description	Definition
14	Audio1 Config	Audio configuration option for AD1 port
15	Audio2 Config	Audio configuration option for AD2 port

Notes: AD1, AD2 can't be allocated to the video input signals in the same channel!

7. Hot Spare setup

LVP605 supports hot spare of input signals, that is to say, once the current input signals are lost, the processor will automatically switch to backup input signals at once, so as to avoid image interruption caused by the fault of signal source.

Item	Description
16	Hot spare < V1→V3>
17	Hot spare < V2→S-Video >
18	Hot spare < HDMI→DVI>
19	Hot spare <VGA1→VGA2>

As above figure shows, if "**Hot spare < V1→V3>**" is turned on, the processor will automatically switch the output image to backup port V3 once signal V1 is lost.

8. Factory district setup

The following are factory district setups, users are recommended to make these setups under the guidance of manufacturer's technicians, any improper setting or operation may result in abnormal happening to the processor.

Item 20: "**Device ID**"

This item is used to number LVP605 while controlling several processors by RS232. The number scale is from 1 to 255.

Item 21: "**ADC Calibration**"

After inputting a analog signal to the video processor whose white balance has not been calibrated, the picture on the display may appear some bad phenomena, such as color cast, extreme-darkness. **LVP605** can solve the above problems by automatically calibrating white balance based on the input analog signals (**CVBS**、**S-Video**、**YPbPr**、**VGA**) . Operating procedures:

Switch to the corresponding analog input signal, enter Item No. 20 "**Device ID**." after the processor detects input signals and exports the signals to the display, press "V1" for 5 times, then press "↑" to shift to Item 21 "**ADC Calibration**", press knob to calibrate white balance.

Caution: The white balance of all video processors has been calibrated using standard signals in the factory, please don't set this item unless necessary!

Item 22: "**Bias**"

In order to decrease the noise on gray scale display, the LED display system usually removes the lower gray scale one of all input signals, which will cause the lose of the video information, especially in dark scene ,such as night view.

LVP605 can improve problems as follow mentioned by adjusting the "**Bias**", whose limit ranging from 0 to 100. When losing the signal of dark scene, you can restore the drop-out information to the LED display by increasing the value.

Normally in order to keep the completeness of output signals, the

standard value is set as **50!**

Item 23: “De interlace”

When **CVBS/S-Video/HDMI/SDI** signals are interlace input formats (e.g.: 1080i) and used as PIP, due to limits of the processor, tremble may take place, it can be dispelled by setting the option “**De interlace**”. Operating procedures:

enter Item No. 20 “**Device ID**”, press “V1” for 5 times, then press “↑” to shift to Item 23 “**De interlace**”, turn knob to select “ON”, and press knob to make it valid.

Item 24: “EXT. model”

This item is used to setup after changing the extended model. So that the model can work normally.

After entering item No. 20 “**Device ID**”, press “V1” for 5 times, then press “↑” to shift to Item 24: “**EXT. model**”, turn the knob to choose related option, then press the knob to save the setup. the moment the system will remind you “**Please restart.**”, just follow the instruction.

Item 25: “Device Init”

After entering item No. 20 “**Device ID**”, press “V1” for 5 times, then press “↑” to shift to Item 25: “**Device Init**”, turn knob to select “Yes”, then press knob to reset the factory settings, the moment the system will remind you “**Please restart.**”, just follow the instruction.

(II) PIP/POP setup

Category		Items	
1	background Output setup	1	Main_Hori_Width
		2	Main_Hori_Start
		3	Main_Vert_Height
		4	Main_Vert_Start
2	PIP Output setup	5	PIP_Hori_Width
		6	PIP_Hori_Start
		7	PIP_Vert_Height
		8	PIP_Vert_Start

LVP605 allows for presetting 4 PIP/POP display modes, each mode allows for setting any background and PIP/POP size and location you need.

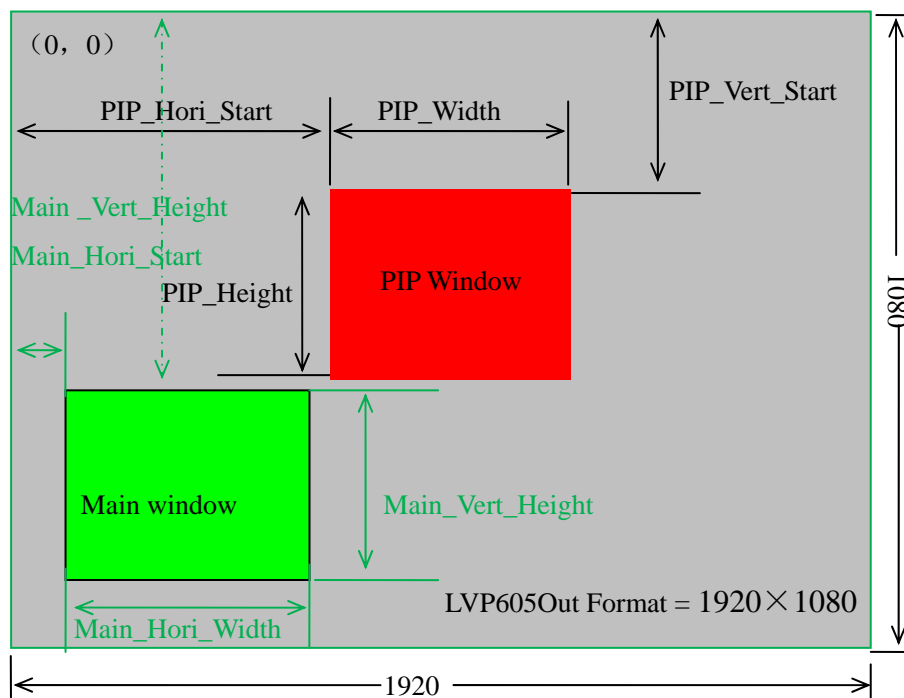

Figure 5

As above figure shows: the size and location of the images in **LVP605 background and PIP** output window for the LED display are defined by the following 8 groups of parameters:

Item	Description
1	<i>Main_Hori_Width</i>
2	<i>Main_Hori_Start</i>
3	<i>Main_Vert_Height</i>
4	<i>Main_Vert_Start</i>
5	<i>PIP_Hori_Width</i>
6	<i>PIP_Hori_Start</i>
7	<i>PIP_Vert_Height</i>
8	<i>PIP_Vert_Start</i>

Operating procedures:

Enter PIP/POP setup mode: while PIP/POP mode is turned on (make sure that Mosaic mode have been switched off), press “**Setup**” button, then press the knob, **LVP605** will enter the first setup item of **PIP/POP** setup mode. The information as follows will

appear in LCD:

1.
Main_Hori_width
1216 ?
PIP/POP Mode=M1

Switch current PIP modes: press mode buttons (i.e.: M1, M2, M3, M4), the processor will directly switch current PIP modes.

Switch adjustment items: press " ↑ " and " ↓ " to switch current adjustment items.

Change output parameters: user can change current parameter settings by rotating the knob. The speed at which you rotate the knob decides the step value of the adjustment. The locations of the background and PIP will be previewed respectively in the white rectangle and blue rectangle while you are making the adjustment, then you can press the knob to save and validate the settings you made.

Exit PIP/POP setup mode: directly press "Setup" button while in **PIP/POP** setup mode, **LVP605** will exit directly.

(III) Mosaic setup

Category		Items	
	Input image setup	1	<i>Out_Hori_Width</i>
		2	<i>Out_Hori_Start</i>
		3	<i>Out_Vert_Height</i>
		4	<i>Out_Vert_Start</i>
		5	<i>In_Hori_Width</i>
		6	<i>In_Hori_Start</i>
		7	<i>In_Vert_Height</i>
		8	<i>In_Vert_Start</i>
		9	<i>Mosaic Mode</i>

The maximum output definition of **LVP605** is 2048×1152 or 1600×1200, to drive so high definition, LED display requires two transmission cards in cascade, so LVP605 provides two locations to hold two built-in transmission cards; if the actual definition of LED display exceeds the maximum output definition of LVP605, you may divide the whole LED into pieces of smaller LED screen, then put them together in Mosaic manner by connecting multiple sets of LVP605 in parallel, so as to integrate the smaller pieces of LED into a large LED display.

With frame synchronization technology, LVP605 solves the problems of misplacement and delay of output image existing in ultra-large LED mosaic, able to provide real-time, clear and fluent displaying effects.

LVP605 supports multi-machine mosaic in parallel, in this way, smaller pieces of LEDs can be integrated into a large display. For example, if the output definition of LVP605 is set as 1920×1080, and we put 2 sets of LVP605 together horizontally in parallel, it will be able to connect any LED display of up to 3840×1080 pixels.

Below is a 2×2 mosaic example using 4 sets of LVP605, telling us how to use multi-machine cascade of LVP605 and what we should pay attention to.

The definition of each LED is 3456×1920, we can divide it into the four small pieces of LED of 1728×960 pixels as shown in figure below, each piece of small LED is driven by a set of LVP605. With total 4 sets of LVP605, the large display of 3456×1920 pixels is able to display a full picture.

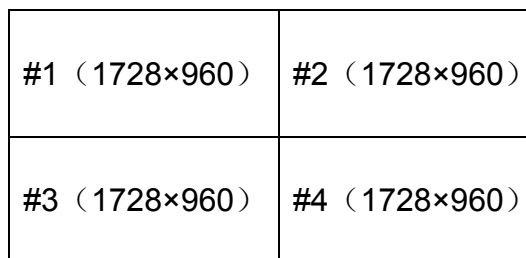

Below is the system topological diagram:

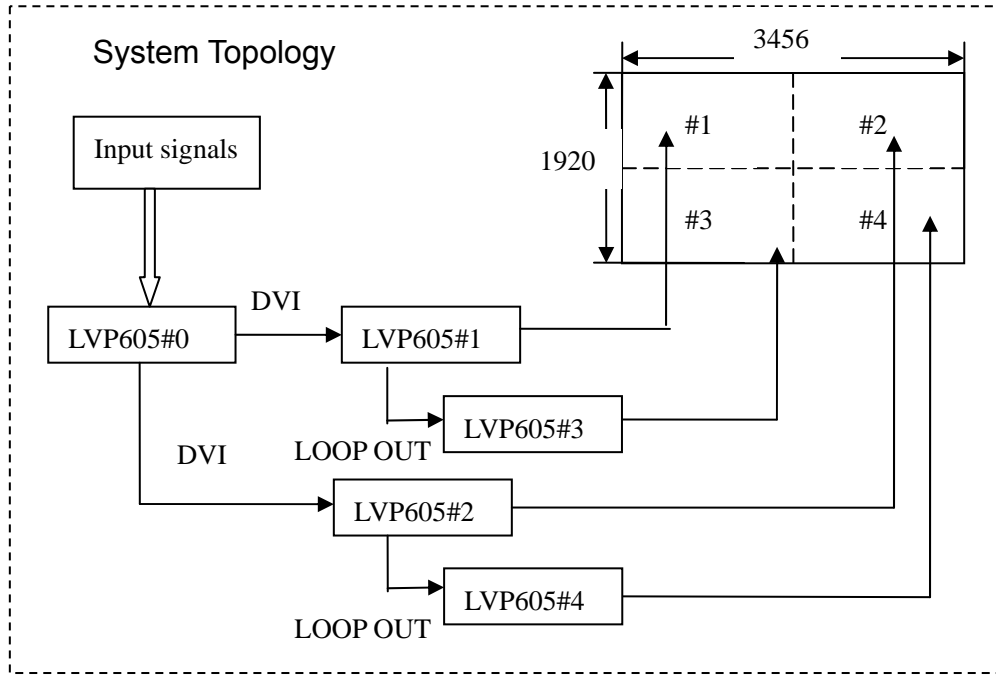

As above figure shows, all input signals are connected to and switched by #0 LVP605, the DVI signals exported by this machine are output via DVI loop of each mosaic processor to 4 sets of LVP605 for cutting or enlarging, the image that they output will be finally displayed as a whole picture in 4 pieces of LEDs.

To use multiple sets of LVP605 in parallel, we should set the parameters of input image for each set of LVP605. The table below lists all the items to be adjusted.

Item	Description
1	<i>Out_Hori_Width</i>
2	<i>Out_Hori_Start</i>
3	<i>Out_Vert_Height</i>
4	<i>Out_Vert_Start</i>
5	<i>In_Hori_Width</i>
6	<i>In_Hori_Start</i>
7	<i>In_Vert_Height</i>
8	<i>In_Vert_Start</i>
9	<i>Mosaic Mode</i>

Caution: while in Mosaic mode, in order to keep the consistency of the image, each processor must be set to be identical in the parameters of brightness/color/gray/definition.

Enter setup: While in operation mode (mosaic mode is turned on), press "Setup" button, then press OK button, LVP605 will enter mosaic

setup item.

Exit setup: press “Setup” button while in setup mode, LVP605 will directly exit setup.

The setup of 5 PCS LVP605 is as follow::

Setup items		parameters of processor				
		#0	#1	#2	#3	#4
1	Out_Hori_Width	1920	1728			
3	Out_Vert_Height	1080	960			
	Out Format	1920×1080				
5	In_Hori_Width	1920	960	960	960	960
6	In_Hori_Start	0	0	960	0	960
7	In_Vert_Height	1080	540	960	540	540
8	In_Vert_Start	0	0	0	540	540
9	Mosaic Mode	Not Sync	Sync			

In order to ensure all output images are synchronous to each other, please note the following settings:

1. The input signals can be only DVI signals, and if the processor is in mosaic mode, it will be unable to switch input signals;
2. All the 5 processors must to be set to be the same in output definitions.
3. Please reduce the number of DVI rings of the processor to the most extent, so as to prevent signal instability caused by signal attenuation.

Items 1~4: “ **Output image setup** ”

Items 3~6 of user setup menu are image output parameters, the parameters adjusted are the data in the same group.

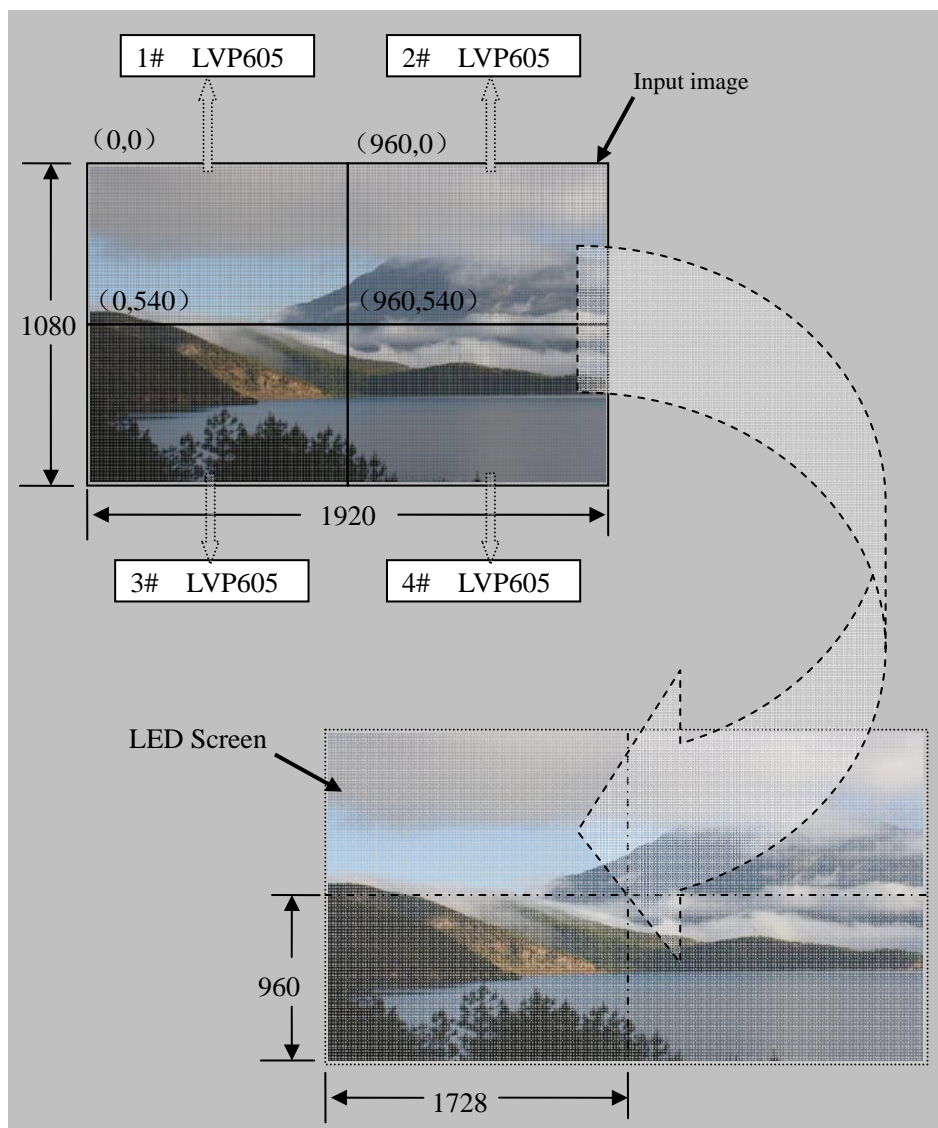

Figure 5

Item 5: “*In_Hori_Width*”

It is used to set the horizontal width of input image from which **LVP605** will capture. As shown in Figure 5, the width of input image for the 4 sets of **LVP605** should be set as:

***In_Hori_Width* = 960**

Item 6: “*In_Hori_Start*”

It is used to set the horizontal start point of input image from which **LVP605** will capture. As shown in Figure 5, the the horizontal start point of the four sets of **LVP605** are set as below respectively:

- 1# LVP605 *In_Hori_Start* = 0
- 2# LVP605 *In_Hori_Start* = 960
- 3# LVP605 *In_Hori_Start* = 0
- 4# LVP605 *In_Hori_Start* = 960

Item 7: “ *In_Vert_Height* ”

It is used to set the vertical height of input image from which **LVP605** will capture. As shown in Figure 5, the vertical height of the four sets **LVP605** are set as below respectively:

In_Vert_Height = 540

Items 6: “ *In_Vert_Start* ”

It is used to set the vertical start point of input image from which **LVP605** will capture. As shown in Figure 5, the the vertical start point of the four sets of **LVP605** are set as below respectively:

- 1# LVP605 *In_Vert_Start* = 0
- 2# LVP605 *In_Vert_Start* = 0
- 3# LVP605 *In_Vert_Start* = 540
- 4# LVP605 *In_Vert_Start* = 540

Item 9: “ *Sync Mosaic* ”

The system provides the options of “Sync Mosaic” and “Not sync Mosaic”. “Sync Mosaic” ensures all output images are completely real-time and synchronous to each other; while “Non-sync Mosaic” has better compatibility, and is usually used for mosaic commissioning.

VI. Specifications

Inputs	
Nums/Type	3×Composite 1×S-Video 1×YPbPr 2×VGA (RGBHV) 1×HDMI (1.3a with HDCP) 1×DVI (HDMI) 1×EXT. (Extended)
Video system	PAL/NTSC
Composite Video Scope/Impedance	1V (p_p) / 75Ω

S-VIDEO Scope/Impedance	Y: 1.0V (p_p) / 75Ω, C: 0.35V (p_p) / 75Ω	
VGA Format	PC (VESA)	≤2048x1152 @60Hz
VGA Scope/Impedance	R、G、B = 0.7 V (p_p) / 75Ω	
DVI Format	SD/HD (CEA-861)	≤1920x1080P @60Hz
	PC (VESA)	≤2048x1152 @60Hz
HDMI 1.3 Format (HDCP)	SD/HD (CEA-861)	≤1920x1080P @60Hz
	PC (VESA)	≤2048x1152 @60Hz
YPbPr Format	SD/HD (CEA-861)	≤1920x1080P @60Hz
YPbPr Scope/Impedance	Y= 1.0V (p_p) / 75Ω Pb= 0.35V (p_p) / 75Ω Pr= 0.35V (p_p) / 75Ω	
SDI format	SDI-SMPTE 259M-C	576i @50Hz 480i @60Hz
HDSDI 3GSDI format	HDSDI-SMPTE 292M SMPTE 274M/296M SMPTE 424M/425M	≤1080P @50Hz/60Hz
AUDIO Scope/Impedance	2.0Vp-p/10KΩ	
Input Connectors	VGA: 15pin D_Sub(Female) DVI: 24+1 DVI_D YPbPr: BNC×3 Composite: BNC S-VIDEO: 4pin mini DIN(Female) SDI/ HDSDI : BNC	
Outputs		
Nums/Type	1×VGA (RGBHV) 2×DVI	
VGA/DVI Format	1024×768@60Hz/75Hz 1280×1024@60Hz/75Hz 1600×1200@60Hz 1920×1080p@50Hz/60Hz 1366×768@60Hz 1440×900@60Hz 2048×1152@60Hz	
VGA Scope/Impedance	R、G、B = 0.7 V (p_p) / 75Ω	
Output Connectors	VGA OUT: 15pin D_Sub(Female) DVI OUT1: 24+5 DVI_I DVI OUT2: 24+1 DVI_D	
Others		
Control	Panel Button,RS232	
Power	100-240VAC 35W 50/60Hz	

Operating Temp	5-40 °C
Humidity	15-85%
Dimensions (Package)	145 mm (height) × 370mm (width) × 535mm (length)
Weight (G.W.)	5.0 Kg
Weight (N.W.)	3.2Kg

Dimensions:

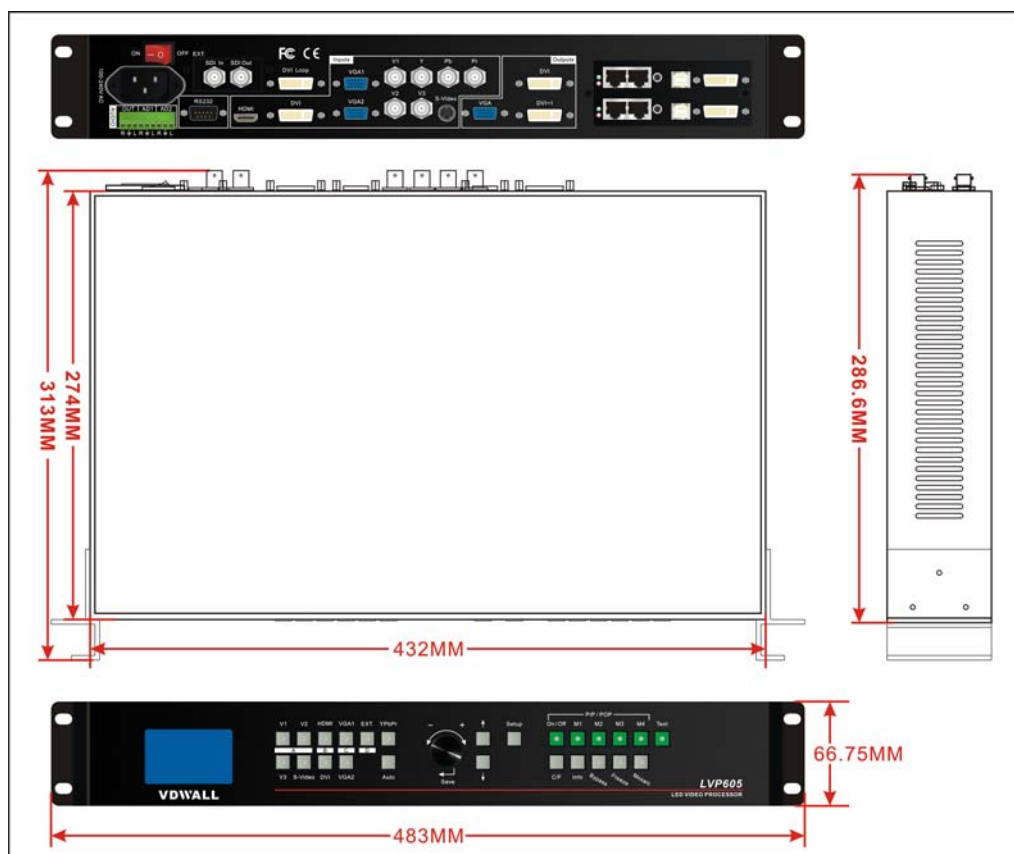

SPEC. of RS232 cable:

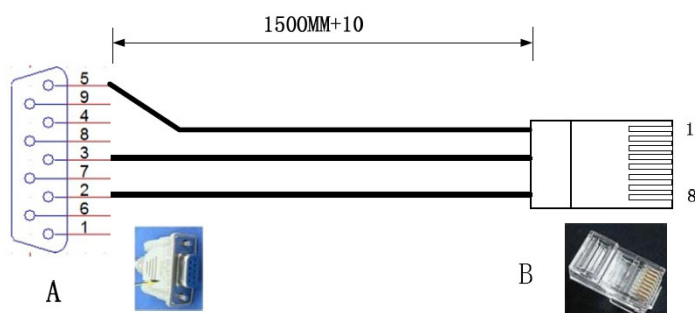

- | | |
|---|-----|
| A | B |
| 2 | 4 |
| 3 | 5 |
| 5 | 3 6 |

VII. ViewRGB LVP605 Control Software User's Manual

ViewRGB LVP605 Control Software is used to control LED HD Video Processor. With this software, we can:

- Select input signal source in Cut or Fade mode.
- Realize 4 custom double-picture display and Text Overlay functions
- Enable and disable Bypass, Freeze and Mosaic functions
- **Configure mosaic parameters of LVP605**
- Realize Timer Control function, switch input signal source under timer plan
- Realize multi-machine cascade fast mosaic function

(I). Control modes

LVP605 LED HD Video Processor can receive operating commands from ViewRGB LVP605 Control Software to switch input signal source or change the brightness of output images. The LVP605 Control Software controls LVP605 LED HD Video Processor via RS232 COM serial port of PC.

User can operate PVP605 manually using the RS232 serial port software supplied by the manufacturer, or create timer control plans, then the serial port software will automatically control LVP605 under these plans.

To do so, first connect COM port of PC to RS232 port of LVP605, then run the control program ViewRGB LVP605 Control Software.exe.

(II). Instructions of software menu

1. Main menu

Double click the software "LVP605 Control Software.exe", the main menu of the software as below will appear:

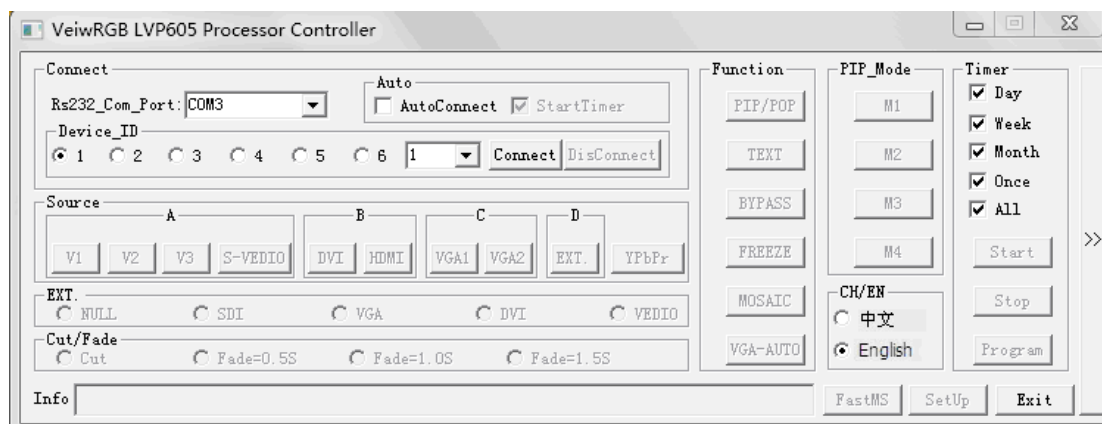

As shown in above figure, the main menu consists of the following parts:

- RS232 COM port setup
- Select signal source
- Switching mode setup
- Information field
- Timer control setup
- Select function modes
- Select PIP modes
- Select language (Chinese/English)
- Configure output parameters (screen setup)
- Multi-machine cascade mosaic setup (Fast Mosaic)

1) Select language (Chinese/English)

The software supports two languages, i.e.: Chinese and English. Here user can select a desired language.



2) COM port setup

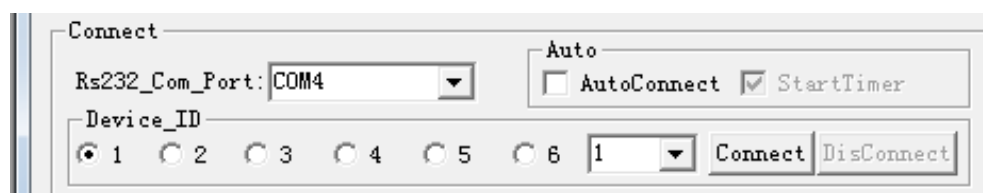

Select a proper COM port in the field RS232_Com_Port, and select a proper device ID. You can view the No. of the COM in the “Device Manager” of control PC as shown below:

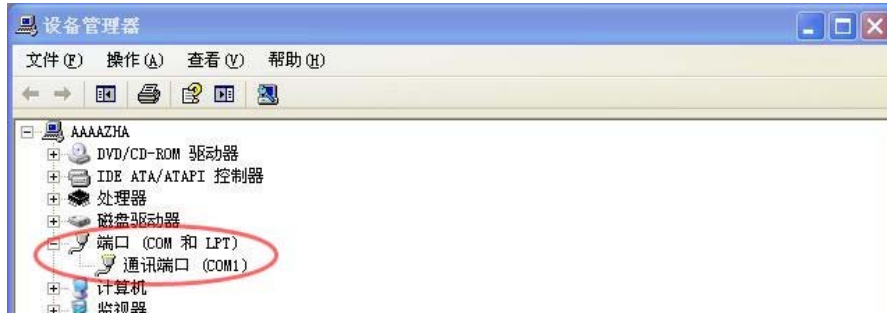

The device ID you selected (from user setup item 21 "Device ID") must be identical to the device ID of LVP605 to be controlled.

Click the button "Connect", the following message will



appear. After the device is successfully connected, the function keys in the main menu of the software will be activated, and the following message will appear in the information field of main menu

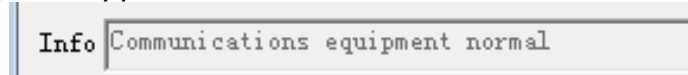

Timer Start Setup: to set whether the machine automatically connects serial port or starts timer control or not when it is started next time.



3) Signal status and signal switching



The buttons of this area respectively represent the corresponding keys and status indicators in the panel of the processor.

After the device is successfully connected, the software will read the input signal source you currently selected and the blue indicator above it will turn on. If the blue indicator illuminates normally, it means the input signal source you currently selected is valid; however, if the blue indicator blinks, it means there are no valid signal input.

Click the signal button to change the input source of LVP605. The software can display the information of current extended modules.

4) Switching mode setup



This function is used to setup signal switching modes. The system provides 4 switching modes, i.e.: Cut, Fade in fade out 0.5s, Fade in fade out 1.0s, Fade in fade out 1.5s.

5) Select function modes



This menu provides the following options: PIP, TEXT (Text Overlay), BYPASS, FREEZE, MOSAIC, VGA-AUTO (VGA automatic adjustment).

PIP/POP modes: while in one picture display mode, click  , the blue indicators before the button and corresponding mode buttons will blink, select PIP as input signal source in the field "Select signal source". If the blue indicator before the button illuminates normally, the picture will be displayed in PIP mode. User can select the preset PIP/POP display effects in the field "PIP_Mode".

While in PIP/POP mode, click  , the system will exit PIP/POP mode.

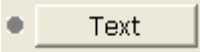
TEXT (Text Overlay): while in one picture display mode, click  , the blue indicators before the button and corresponding mode buttons will blink, select TEXT as input signal source in the field "Select signal source". If the blue indicator before the button illuminates normally, the information will be displayed in TEXT overlay mode.

While in TEXT mode, click  again, the system will exit TEXT mode.

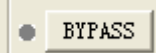
Bypass: when current input sources are PC signals like VGA/DVI/HDMI, click  , the blue indicators before the button will illuminate normally, and the PC signals will be displayed in part screen, otherwise they will be displayed in full screen.

Freeze: while in operation mode, click  , the current output picture in the processor will be frozen. Click the button again or perform any other signal switching operation, the processor will exit Freeze mode.

VGA-AUTO: when current input source is VGA signal and the

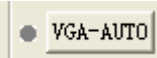
input signal is valid, click  , the processor will sample the current input signals to make the output pictures full and clear.

6) Timer control setup

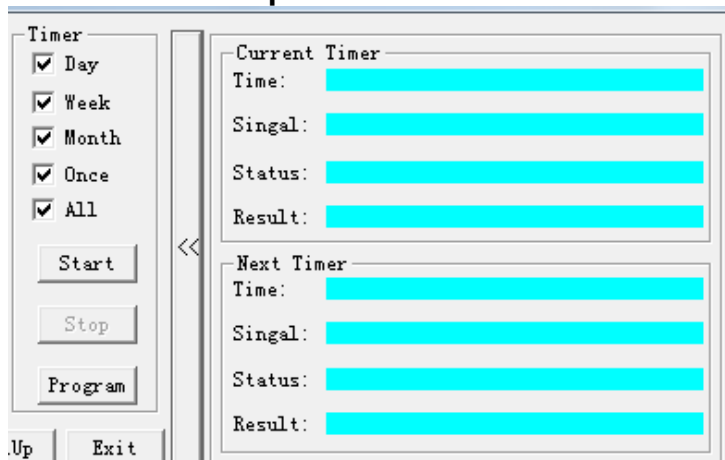

The Timer of the Control Software can switch the input signal source of LVP605 as per the preset timer plan. The system provides four cycle timer modes, i.e.: Day, Week, Month, Once.

Select a preset timer plan, then click “Start”, the Timer you selected will start to work immediately. To stop Timer control, click “Stop”.

Click “Program” to enter timer setup menu, where you can view the timer plan you already set, or add, modify, delete timer plans. For details, please refer to the Chapter “Instructions of Timer Setup Menu”

Once the timer is started, LVP605 Control Software shouldn't be closed, otherwise the timer will not work.

7) Information



If an operation fails, the reason for which current operation fails will appear in the information field.

2. Output parameters configuration (screen setup) menu

Click  , in main menu, the system will enter output parameters configuration menu as shown below:

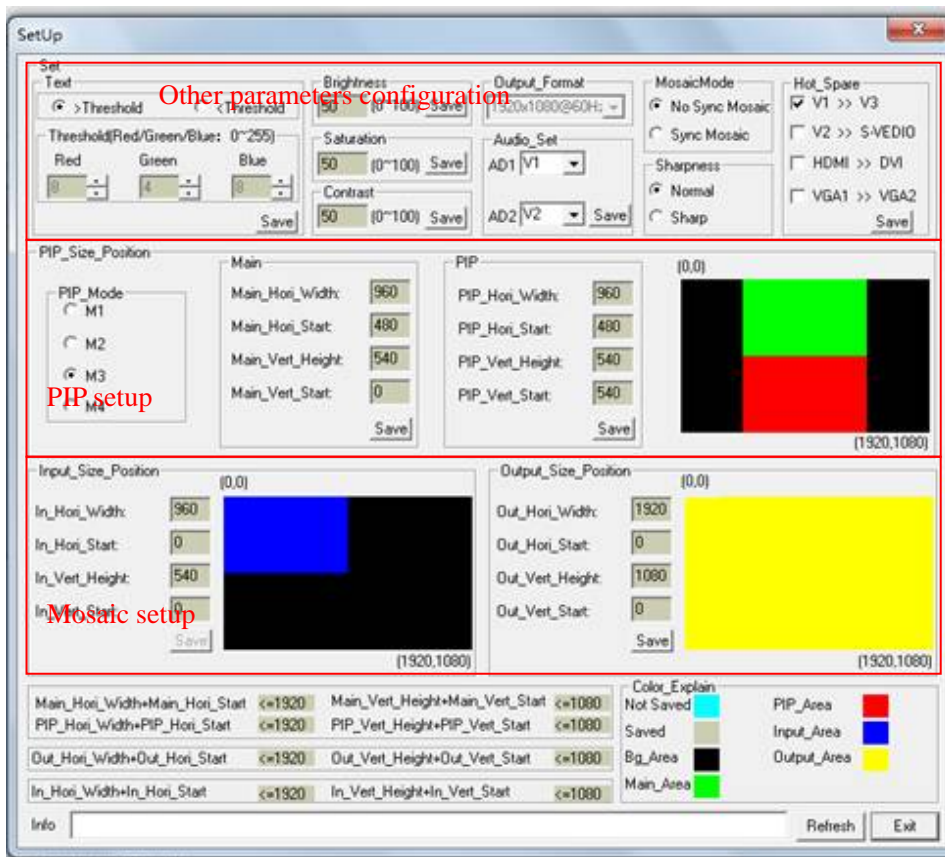

As shown in above figure, the button “Refresh” is used to update the information of currently processing parameters after parameters configuration is finished. Any abnormal of parameter will be reminded in info field.

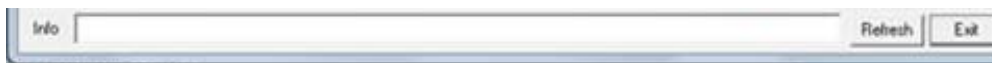

The current output resolution of the processor is displayed in software interface, but it can't be set by the software.

In addition, among all parameters appearing in the menu, those in walhet background color are the parameters not yet entered or saved; while those in grey background color are the parameters already saved.

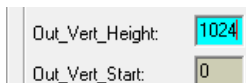

See the figure on the right hand:

Screen output parameters configuration include the following items:
1) Image input/output parameters configuration and mosaic mode setup.

The parameters of output windows should be configured to the actual pixels of the screen to be driven.

Mosaic mode setup and input image parameters configuration apply to multi-machine parallel mosaic. The mosaic options are provided

to set whether the processor adopts synchronous or non-synchronous mosaic mode. Input image parameters are used to set the location and size of the images to be captured from input image based on the actual size of the screen.

Caution: input image parameters shall not be configured unless the following conditions are met:

- a. The input signal of the processor is DVI.
- b. The resolution of DVI input signals is the same with output resolution of the processor.
- c. The processor is in Mosaic state (the Mosaic indicator illuminates normally).

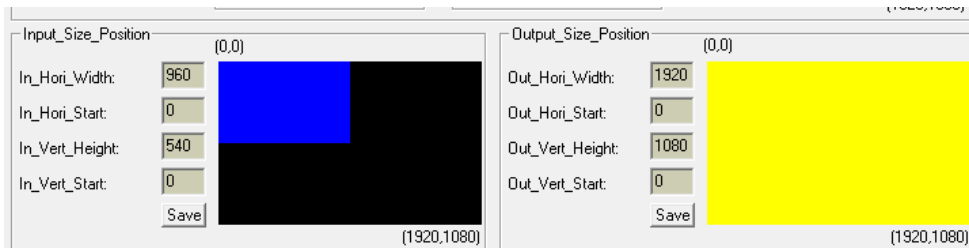
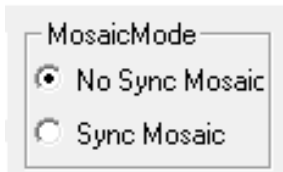

2) POP/PIP display setup (location and size of PIP windows)

This menu is used to set the four PIP/POP display modes of LVP605.

First, select a PIP mode to be adjusted, then enter the parameters of background, location and size of PIP windows, then click “Save” button to save the parameters in the processor.

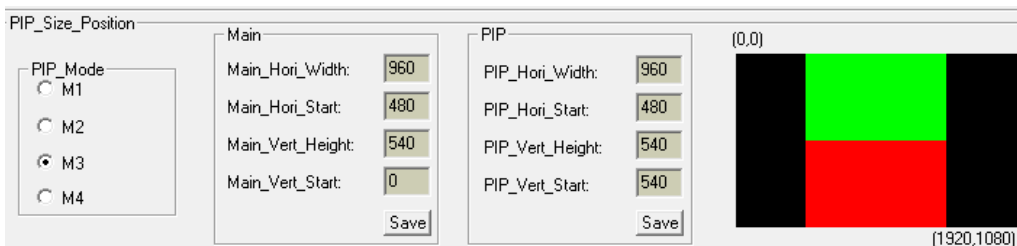

3) TEXT setup

It is used to set the red, green and blue threshold values of valid information of the text signals to be captured by the processor, also to set whether the text is greater or less than threshold values, select appropriate threshold values, click “Save” button to save them in the processor.

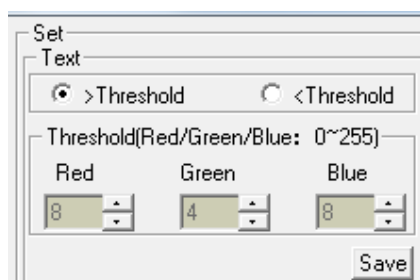

4) Brightness, color, contrast, sharpness setup

This option is used to set brightness, color, contrast, sharpness of output images, enter the desired parameters, then click “Save” button. To set sharpness, directly click “Normal” or “Sharp”, the parameters will be saved.

Notes: the default values of brightness, color, contrast are all 50.

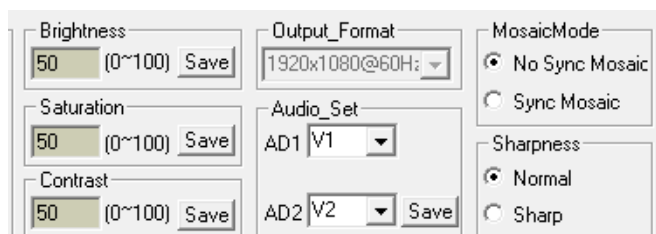

5) Audio setup

This option is used to set AD1, AD2 audio port as the corresponding video input port, so as to realize synchronous switching of audio/video signals.

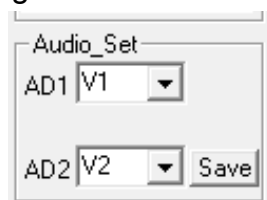

6) Hot spare setup

This option is used to turn on/off the hot spare function of the following four groups of input signals.

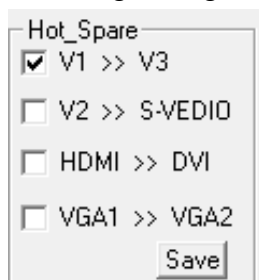

3. Timer setup menu

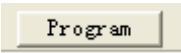
Click  in main menu, the system will enter Timer setup menu as shown below:

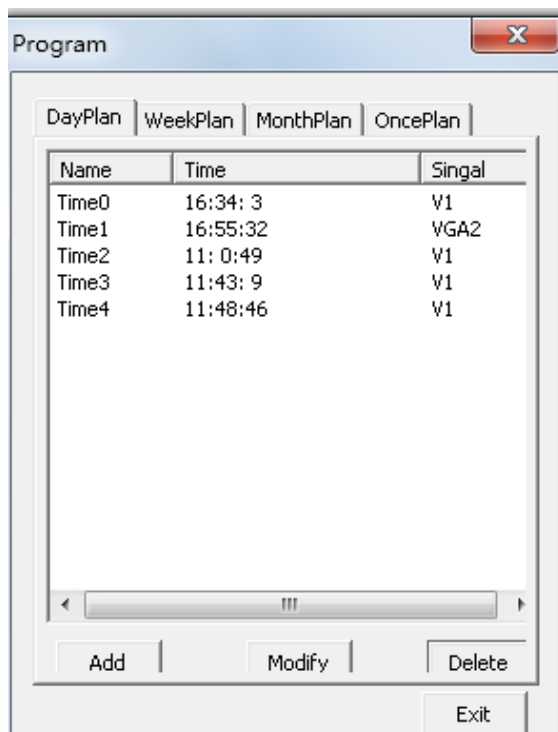

As shown in above figure, there are two types of plans:

- ◆ **Cycle Plan**
- ◆ **Once Plan**

Cycle Plan is sub-divided into three types:

- ◆ **Day Plan**
- ◆ **Week Plan**
- ◆ **Month Plan**

User can select one type he desires

The plan items of Day Plan define hours, minutes, seconds;

Each week has 7 days, so the plan items of Week Plan define week day, hour, minute, second;

Each month has maximum 31 days, so the plan items of Month Plan define date, hours, minutes, seconds;

The plan items of Once Plan define year, date, hours, minutes, seconds;

Cycle plan and once plan can work together.

For each type of plan, the plan items can be added, modified,

deleted. For example, the figure below shows how to add plan items to a day plan.

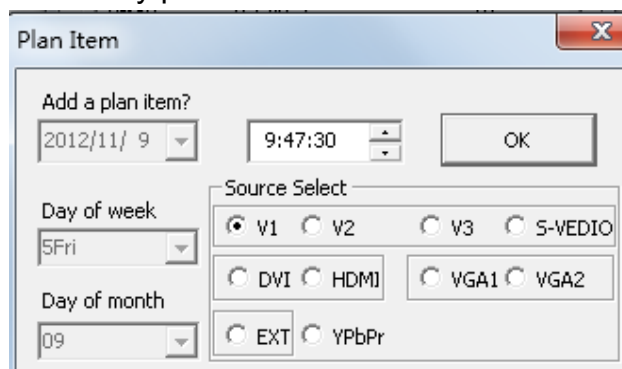

Select the plan already added, then you can modify or delete it.

4. Fast Mosaic menu

LVP605 can drive ultra high-definition LED display through multi-machine cascade mosaic. User can complete input/output parameters configurations of each ser of processor through fast mosaic menu.

In this menu, user only need select mosaic mode (namely how a large is divided into a number of smaller pieces of LED) and the actual pixels of each LED driven by each set of processor, the program will automatically calculate the mosaic parameters of each set of processor and save them in the corresponding processor.

Enter Fast Mosaic Menu: after entering main menu of LVP605, click , the menu as below will pop up.

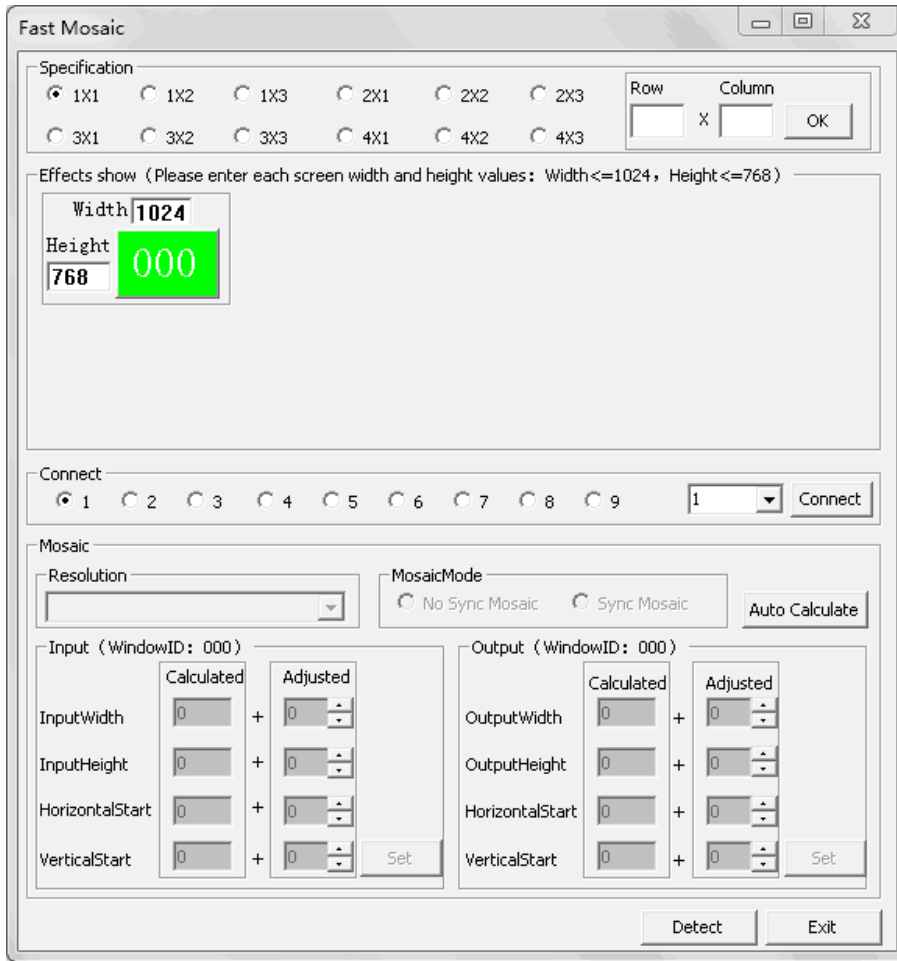

Caution: before making the mosaic settings, please make sure the following conditions have been met:

- 1) All processors are the same with each other in brightness, color, contrast and definition.
- 2) All processors must use the same output resolution, and make sure it the same with that of input DVI signals.
- 3) The current input source of all processors is DVI signals, and make sure the Mosaic function is enabled (Mosaic indicator illuminates normally).

Steps of Mosaic setup:

Before performing mosaic setup, make sure that each LED display and processor are working well, and that each LED display is able to display a full picture independently. Connect all the processors or the first processor to be adjusted via serial ports.

- 1) Connect processors using software.

Select the device ID of the first processor to be adjusted (from user setup item 21 “Device ID”), click “Connect”, the processor will automatically connect the processor, the software will read and

display the current parameters (e.g.: output resolution) of the processor.

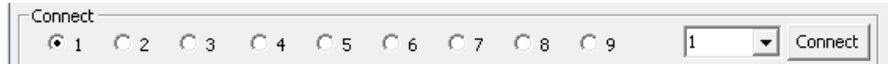

2) Select mosaic mode

Select current mosaic mode in "Specification" field, namely set how many rows and columns the divided pieces of smaller LED will be arranged. User can also manually enter the number of rows and columns then click "OK". For the LED of 3648x2016 pixels, it should select 2x2 mosaic mode.

3) Enter actual parameters of each LED

After selecting proper mosaic mode, the field "Effects show" will display the actual layout of each LED in models, enter the width and height of each LED display in turn as shown in Figure below:

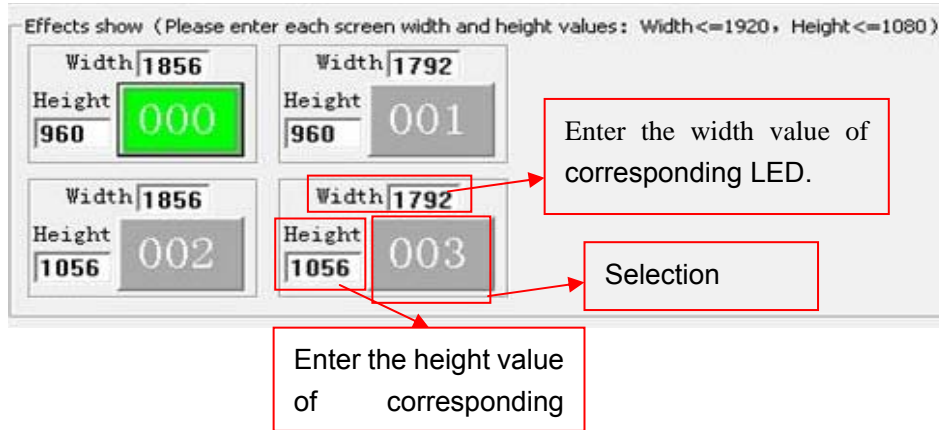

4) Parameters configurations of the first processor

Select the No. of the LED for showing effect in the field "Effects show" (we select the first LED **000**), click "Auto calculate", the processor will automatically calculate the due parameter values of current processor based on the parameters entered in "Effects show". Select the Mosaic mode you desire, and select Sync Mosaic for the LED, the software will pop up the message "Configuration is successful". Click "Set" button respectively in input and output field, the software will automatically save the parameters that it worked out in current processor.

Caution: both input and output parameters of LVP605 must be even, but the results of auto calculation may be odd, if so, it is necessary to set an adjusted value to correct the parameters to be even, then you can click "Set" to save it.

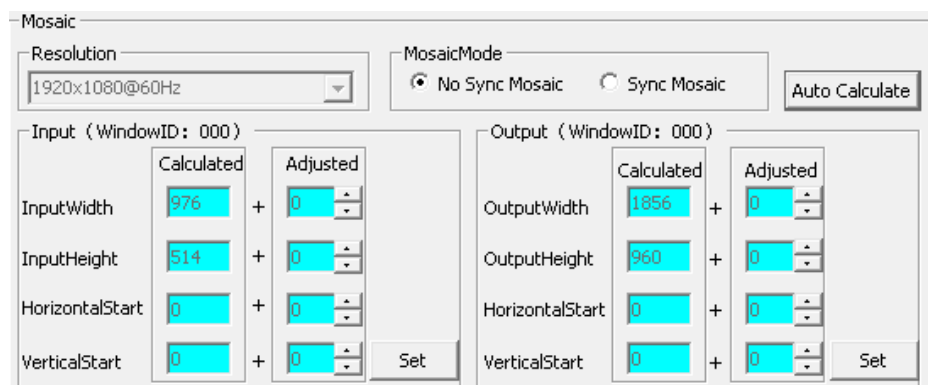

5) Parameters configuration of other processors.

Connect other processors to be set in turn using RS232 cable, select device ID, select No. of corresponding LED following above step 4), the system automatically calculates the parameters of the processor, then select Mosaic mode. Complete parameters configurations of other processors in this way.

VIII. Notes to model

LVP605D: with VGA/DVI/HDMI extended model

LVP605S: with SDI/HD-SDI extended model

LVP605: with VIDEO extended model

IX. Copyright info

The copyright of this Manual is owned by SHENZHEN VD WALL CO.,LTD., unless with prior consent of VD WALL, nobody is permitted to copy or use any part or all of the information contained herein.

This Manual is provided for reference only, VD WALL reserves right to change the product appearance, dimensions and specifications from time to time without notice to users.